



# GERMZONE<sup>®</sup> 100



 **Made in USA**  
from US and Int'l Components



## TABLE OF CONTENTS

SAFETY INFORMATION .....	3
OVERVIEW OF AIR QUALITY.....	6
UNPACKING .....	6
INSTALLATION .....	7
OPERATION .....	8
MAINTENANCE .....	9
ADDITIONAL INFORMATION .....	14
CUSTOMER SUPPORT & WARRANTY .....	15

**THIS PRODUCT IS NOT MARKETED IN  
THE UNITED STATES FOR THE  
DIAGNOSIS, TREATMENT OR  
PREVENTION OF ANY DISEASE.**

GermZone® reserves the right to change specifications contained in this document at any time without prior notice. If you have questions about the use of this product, contact your customer service representative. Refer to the Customer Support section located in this guide.

© 2020 GermZone® powered by Aerobiotix®, Inc. All rights reserved. Patents pending.



## **IMPORTANT SAFETY INFORMATION**

---

### **About this User Manual**

Congratulations on your purchase of this GermZone® 100 high-performance air purification and disinfection system. Please study this user manual carefully to familiarize yourself with the special features and functions of your system prior to use and keep it in a safe place for future reference.

**WARNING: NOT SUITABLE FOR USE WITH SOLID-STATE SPEED CONTROLS.**

**AVERTISSEMENT: NE CONVIENT PAS A DES REGULATEURS DE VITESSEA SEMI-CONDUCTEURS.**

**WARNING: TO REDUCE THE RISK OF ELECTRIC SHOCK DO NOT EXPOSE TO WATER OR RAIN.**

**AVERTISSEMENT: POUR RÉDUIRE LE RISQUE DE CHOC ÉLECTRIQUE NE PAS EXPOSER À L'EAU OU À LA PLUIE.**

The following symbols are found in your user's manual or on labels affixed to the unit itself:

**Note:** This means pay particular attention. Notes contain helpful suggestions.



**CAUTION:** This symbol means be careful. You are capable of doing something that might result in injury, death, or damage to equipment.



**WARNING:** This symbol means UV Radiation. You may be exposed to UV Radiation that could cause eye or skin injuries.

### **General Cautions & Electrical Safety**

---



Always disconnect the power from this air cleaner by unplugging the power cord before adding or removing parts and before cleaning.



Do not use the unit in wet environments. If, for any reason, the unit gets moisture of any kind inside stop use and contact customer service.



Do not operate in the presence of flammable gasses or liquids.



The unit must NOT be used for the abatement of asbestos or other hazardous materials.























Shock and mechanical hazard: Be certain to unplug the unit before performing any service or opening the cabinet.



Prior to changing the filter or UV-C lamps be sure to turn the unit off, then unplug the power cord.



-  Do not operate the unit with the filter removed.
-  Do not operate the unit with the cover removed.
-  Do not insert any objects in any of the vent holes on the machine.
-  Do not exceed the power rating of the unit; this may damage or destroy unit.
-  Do not use adapters or extension cords.
-  Do not use this air cleaner as sole protection against harmful pollutants.
-  Do not operate this air cleaner if it has a damaged cord or plug, if one of the fans fails to rotate, if it is not working properly, if it was dropped or damaged, or if it was dropped into water.
-  Only use this unit for its intended purpose of air cleaning in non-industrial environments.
-  Do not use this unit in areas with very high concentrations of dust or powder to prevent the danger of dust explosions.
-  Do not use attachments or filters not recommended for GermZone® 100.
-  Do not use outdoors.
-  Do not obstruct the air inlet and air outlet of the air cleaner.
-  Only use the supplied mounting system to attach the unit to the wall.
-  Do not place the unit on a soft surface such as a bed or other soft furnishings.
-  Only use this air cleaner in an upright position.
-  Do not place next to a humidifier.
-  Keep the power cord away from heated surfaces.
-  Do not stack heavy objects on the power cord; this may result in electric shock or fire.
-  Turn the power switch to off before unplugging the power cord.
-  Do not stack items on top of the unit.



## IMPORTANT SAFETY INFORMATION (CONT'D)

---



Disconnect the power immediately if strange sounds, smell, or smoke comes from the unit.



Use only on correctly grounded circuits.



Do not allow children or others to climb or sit on unit. Falling of the unit can result in injury.



Do not hang objects from the unit or power cord.



Do not use the unit in a window.



Prop. 65 Warning for California Residents. **WARNING:** This product may contain chemicals known to the state of California to cause cancer, birth defects, or other reproductive harm.



UV Lamps, like all fluorescent lamps, contain mercury and must be handled and disposed of properly. Refer to: <http://www.epa.gov/wastes/hazard/wastetypes/universal/lamps/recycle.htm> for additional information on how to dispose or recycle lamps.



**CAUTION:** – Use of controls or adjustments or performance of procedures other than those specified herein may result in hazardous radiation exposure.



### WARNING

The GermZone® 100 contains two 16-watt ultraviolet lamps. The lamps are designed to disinfect the airstream from viruses, molds, and bacteria. The lamps automatically turn on when the unit is turned on. **NEVER OPERATE THE GERMZONE® 100 WITHOUT THE COVER IN PLACE, WITH THE CABINET DAMAGED, OR WITHOUT THE FILTER IN PLACE. PROLONGED EXPOSURE TO ULTRAVIOLET RAYS CAN RESULT IN SKIN OR EYE IRRITATION.**

**WARNING -** Skin or eye damage may result from directly viewing the light produced by the lamps in this apparatus. Always disconnect power before re-lamping or servicing. Replace lamp with lamp P/N L1-0040-1, sold by GermZone®.

**AVERTISSEMENT -** Des dommages à la peau ou aux yeux peuvent résulter de la visualisation directe de la lumière produite par la lampe dans cet appareil. Débranchez toujours l'alimentation avant de remplacer ou de réparer. Remplacez la lampe par la lampe Référence L1-0040-1, vendue par GermZone®.

You may notice a soft blue glow from the grilles of unit in dark environments. This is normal, and this blue light does not contain ultraviolet rays. Significant ultraviolet exposure can result from DIRECT exposure to the UV lamps themselves.



## **OVERVIEW OF INDOOR AIR QUALITY**

---

The GermZone® 100 is designed to remove contaminants from the air using a combination of filtration and an ultraviolet disinfection system to deactivate microbes from the air.

In order to get the best performance from your system, certain factors should be considered:

- The larger the room, the more time it will take for the unit to complete a full delivery cycle of treated air.
- The sources of air contamination should be considered and reduced as much as possible.
- Ventilation is important to air quality, and a source of fresh air for the room should be available.
- As the unit's filter becomes saturated, soiled or obstructed, the treatment efficiency will decrease. In unusually dirty or dusty environments, filter changes will need to be more frequent.

## **UNPACKING YOUR UNIT**

---

Before shipping, the GermZone® 100 and packaging has been inspected and approved. Follow the step by step instructions to safely remove the unit.

- Open the top of the box.
- Carefully lift the unit out of the box.
- Remove the packaging foam from the ends of the unit.
- Remove the wall mount plate from the back of the unit.
- Your unit is ready for installation.



## **INSTALLATION**

---

The choice of location for your GermZone® 100 unit is a key factor to its performance. You should place the unit in the room in which you want to focus your air treatment strategy. Additionally, the unit should be placed as close as possible to any obvious sources of room air contamination.

### **Installation tips**

- Install the unit on the wall so that furniture or other items do not obstruct it.
- Install the unit sufficiently high to avoid inadvertent contact while leaving clearance to the ceiling. Consult your local building and fire codes for guidance specific to your area.
- Installation of a 120-volt AC grounded wall receptacle may be required. If so, have a licensed electrical professional perform the installation.



**CAUTION:** Never attempt to plug the unit into an ungrounded receptacle. This could result in electric shock, injury or death.

- Install the unit away from areas where it is likely to get wet, or where objects can be inadvertently placed on top of or against it.

### **Installation Instructions**

1. Remove the unit from the packaging.
2. Remove the wall mount plate from the back of the unit. You may need to slide the plate down and pull away from the back of the unit.
3. If installation of a 120-volt AC grounded wall receptacle is required, ensure the receptacle is installed sufficiently close to the wall mounting location so the cord can easily be plugged in without tension on the cord.
4. Place the wall mount plate on the wall at the desired location, ensuring the mounting holes do not align with interior wall studs and that the plate is level. The wall anchors open when installed and require 2 inches of clearance from any obstructions inside the wall.
5. Mark the locations of the holes in the wall mount plate on the wall.
6. Place the wall mount plate aside and using a Phillips head screwdriver; drive the wall mount anchors through the drywall at the marked locations.
7. Install the wall mount plate using the screws provided with the wall mount anchors.
8. Align the mounting holes on the back of the unit with the studs on the wall mount plate.
9. Slide the unit over the studs and gently but firmly pull the unit down until the top of the unit is aligned with the top of the wall mount plate and the locking tab on the top of the plate slides over the top of the unit.
10. Plug in the power cord ensuring there are no obstructions and it is not in the path of any moving objects.
11. Power the unit on.

## OPERATION

---

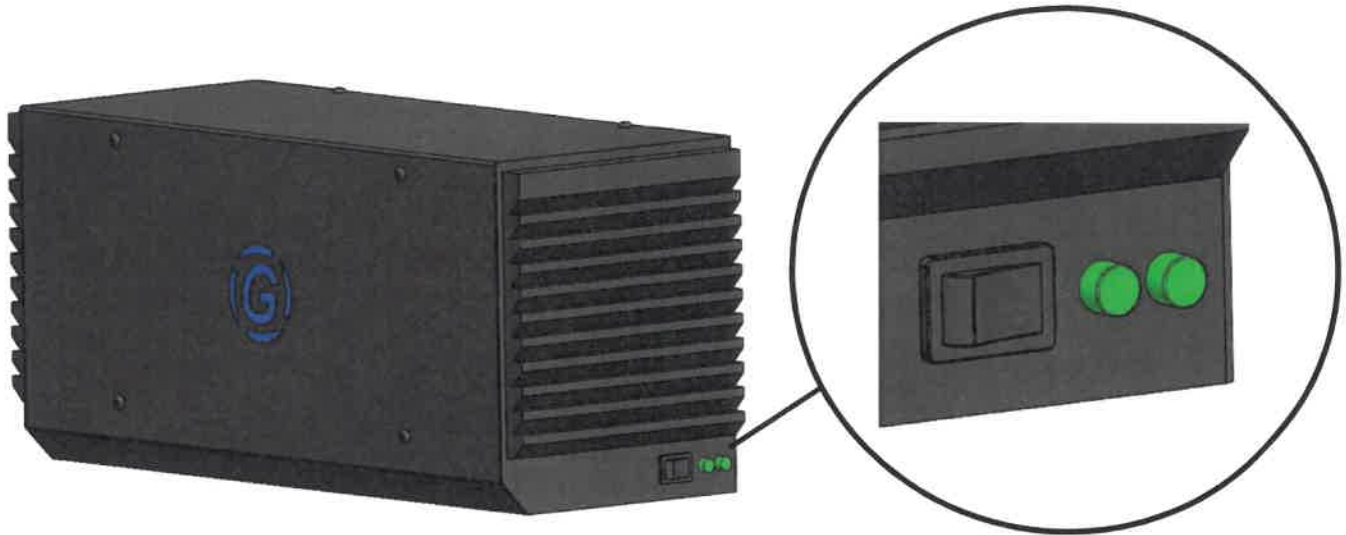

The POWER switch is located on the right side when facing the front of the unit. The GermZone® 100 has been engineered to operate at one predetermined speed for maximum efficiency in producing clean air.

Beside the power switch, indicator light(s) indicate when the ultraviolet lamps are working properly. If the indicator light(s) fail to illuminate, but the fan of the unit is running, this indicates that the UV lamp(s) need to be replaced. Contact customer service for authorized replacement lamps.





## **MAINTENANCE**

---

### **Maintenance Schedule**

The maintenance schedule below is based on continual daily operation of the GermZone® 100.

**Filters:** Replace the filter (P/N: GZ-200-200) approximately every 6 months. If the GermZone® 100 is operating in an excessively contaminated environment, changing the filter more frequently is advised.

**UV Lamps:** Replace the UV lamps (P/N: L1-0040-1) every 8000 hours of operation or approximately every 2 years. Sooner if indicator lamp fails to illuminate.



**CAUTION:** Use only genuine GermZone® 100 replacement filters and lamps to ensure proper filter fitment and function of your GermZone® 100. Failure to use specified products voids warranty.



### Filter Replacement Instructions

There is one replaceable filter, on the same end of the GermZone® 100 as the power switch.



**CAUTION:** Turn off and unplug the unit prior to starting the filter replacement procedure. Failure to do so may result in electrical shock, ultraviolet exposure, injury or death.



1. Power the unit off and unplug from the wall outlet.
2. Remove the fan cover on the same side as the power switch by gently prying the top of the cover away from the case of the unit. A flat bladed instrument such a flat-head screwdriver may be used to accomplish this.
3. Remove the filter.
4. Insert the new filter.
5. Align the fan cover with the louvers pointing up as shown in the image above.
6. Apply gentle pressure to snap the fan cover back onto the case of the unit.
7. See Discarding Used Filters in Additional Information Section for information on the disposal of the old filter.



### UV Lamp Replacement Instructions



**CAUTION:** Turn off and unplug the unit prior to starting the filter replacement procedure. Failure to do so may result in electrical shock, ultraviolet exposure, injury or death.



**ULTRAVIOLET WARNING:** Confirm that the unit is turned off and unplugged before attempting to replace the UV lamps, and confirm that unit is completely re-assembled with the filter in place before plugging back in and powering the unit on.

1. Power the GermZone® 100 off and unplug the power cord from the wall outlet. Remove the GermZone® 100 from the wall mount plate by depressing the locking tab at the top center of the wall mount plate and lifting the unit upwards and then away from the wall.



2. Remove the eight (8) cover screws using an 8/32" Allen wrench.
3. Turn the unit over so the lamp connectors are facing up.

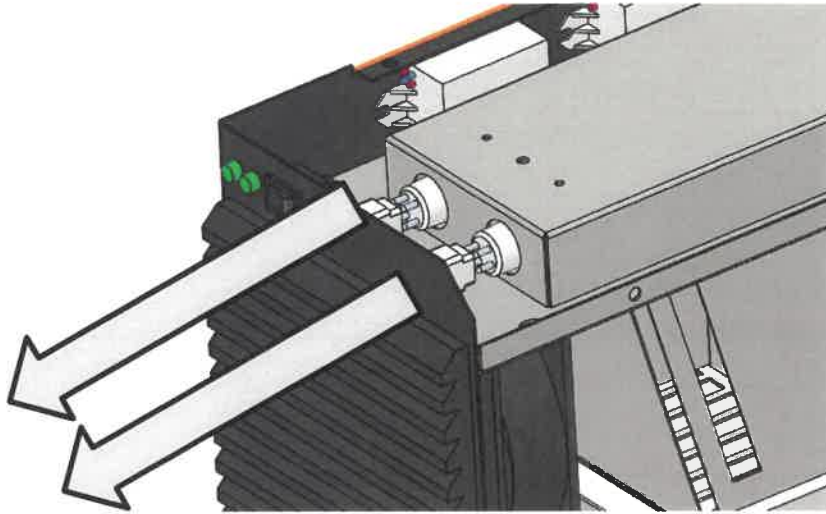

4. Gently remove the four-pronged plugs from both lamps by sliding straight off.

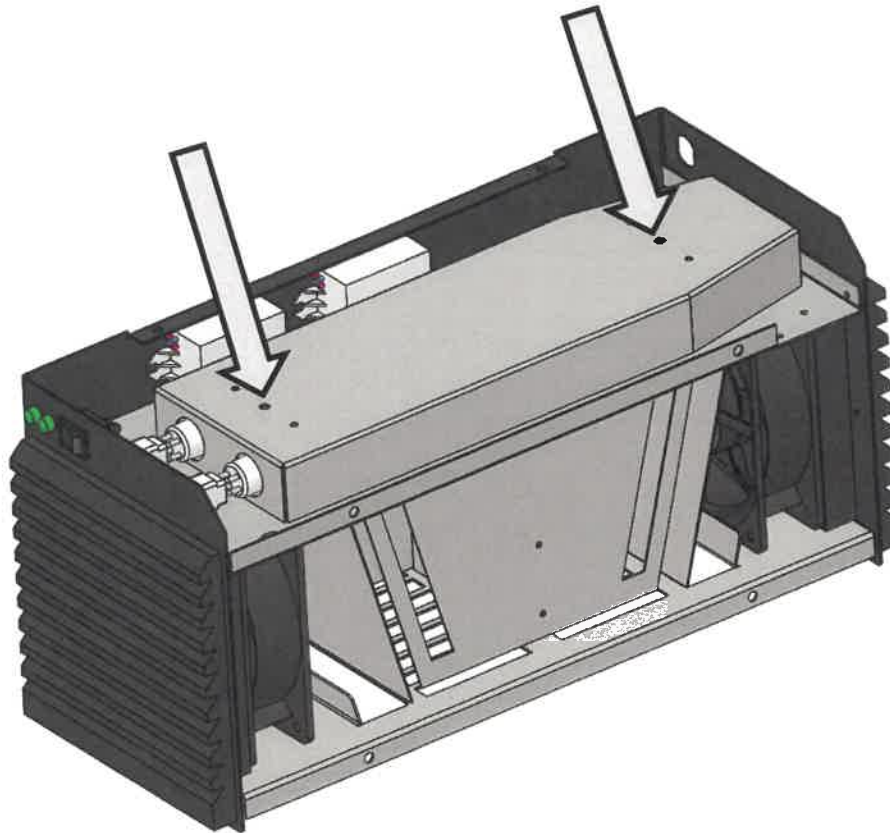

5. Remove the two (2) nuts securing the lamp cover to the chassis.

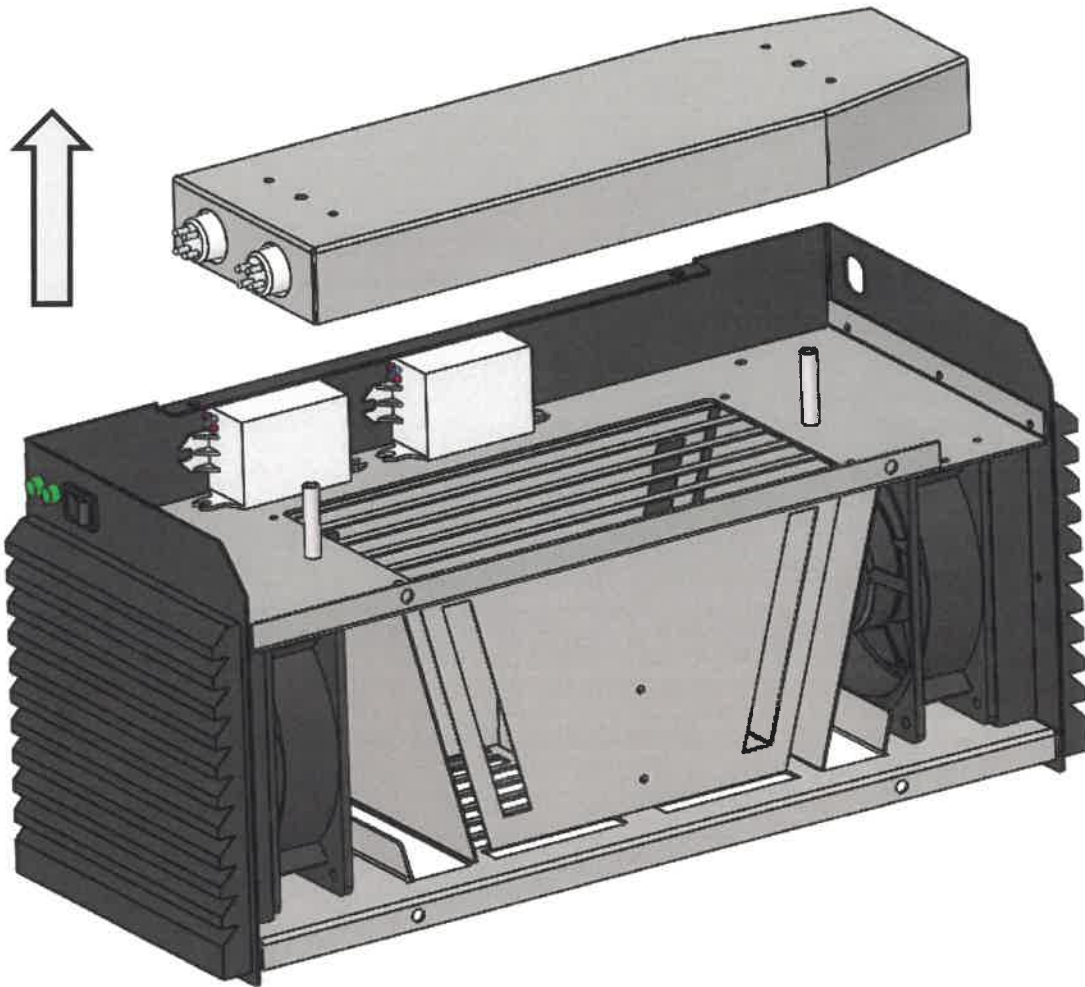

6. Remove the lamp cover assembly from the chassis.
7. Gently remove the lamps from the retaining clips inside the cover.
8. Remove the lamps from the lamp cover.



**CAUTION:** Do not hit the lamps against the metal housing, as this may cause breakage. UV Lamps, like all fluorescent lamps, contain mercury and must be handled carefully.

9. Reverse the above procedure to install the new lamps and reassemble. During reassembly, ensure no wires are captured between the lamp cover and the chassis.
10. Remount the GermZone® 100 on the wall mount plate.
11. See Discarding Used Lamps in Additional Information Section for information on the disposal of the old lamps.



## **ADDITIONAL INFORMATION**

---

### **System Fuse**

If the unit fails to turn on when the power switch is in the on position, this may indicate that the system fuse has blown and needs to be replaced. The fuse is located on the bottom of the unit and is accessed by removal of the front cover as described in the lamp replacement procedure. Contact Customer Service for authorized replacement fuses.

### **Discarding Used Filters**

Used filters can normally be put into regular household trash for disposal. If the system has been exposed to potentially hazardous substances, the filters may have to be disposed of as hazardous waste. Please refer to local regulations and laws for proper handling and disposal.

### **Discarding Used Lamps**

UV Lamps, like all fluorescent lamps, contain mercury and must be handled and disposed of properly. Refer to <https://www.epa.gov/hw> for additional information on how to dispose of or recycle used lamps.

### **Blower and Blower Motor**

The fans are maintenance free and are designed to last the lifetime of the unit. If a malfunction of the fan(s) occur, contact customer service.



## **CUSTOMER SUPPORT**

---

Call GermZone® Monday through Friday 9AM to 5 PM ET at **888-530-8558**. If your call is made after business hours or on weekends, please leave your name, telephone number, and a brief description of the problem. A representative will call back at the earliest opportunity.

You may also visit [www.germzone.com](http://www.germzone.com).

## **WARRANTY INFORMATION**

---

GermZone® warrants this GermZone® 100 product to be free from defects in material, manufacture and design for a period of three years. If this product is defective in materials, manufacture or design during this warranty period, GermZone® will, at its option, repair or replace the product. Repair parts and /or replacement products may be either new or reconditioned at the discretion of GermZone®. This limited warranty does not include service to repair damage from improper installation, improper connections with external electrical fault, accident, disaster, misuse, abuse or modifications to the product not approved in writing by GermZone®. Any service repair outside the scope of this limited warranty shall be at applicable rates and terms then in effect.

All other express and implied warranties for this product including the warranties of merchantability and fitness for a particular purpose are hereby disclaimed. Some states do not allow the exclusion of implied warranties or limitations on how long an implied warranty lasts, so the above limitation may not apply to you.

If this product is not as warranted above, your sole and exclusive remedy shall be repair or replacement as provided above. In no event will GermZone®, or any of its authorized sales and service representatives be liable to the customer or any third party for any damages in excess of the purchase price of the product. This limitation applies to damages of any kind including any direct or indirect damages, lost profits, lost saving or other special, incidental, exemplary or consequential damages whether for breach of contract, tort or otherwise or whether arising out of the use of or inability to use the product, even if GermZone® or an authorized GermZone® representative or distributor has been advised of the possibility of such damages or of any claim by any other party. Some states do not allow the exclusion or limitation of incidental damages for some products, so the above limitation or exclusion may not apply to you.

This warranty gives you specific legal rights, and you may also have other rights that may vary from state to state.